

Welcome!

Everyone at Altinex greatly appreciates your purchase of the TP315-102. We are confident that you will find it to be reliable and simple to use. If you need support, please do not hesitate to call us at 714-990-2300.

At Altinex, we are committed to developing unique and state of the art Signal Management Solutions® for demanding audiovisual installations. Welcome to the Altinex family of satisfied customers around the world!

1. Precautions and Safety Warnings

- Please read this manual entirely before using your TP315-102. You can download a full version of this manual at www.altinex.com. These instructions are to ensure the reliable operation of your switcher and to prevent fire and shock hazards. Please read them carefully and heed all warnings.

1.1 General

- Qualified Altinex service personnel or their authorized representatives must perform all service.

1.2 Installation Precautions

- To prevent fire or shock, do not expose this unit to water or moisture. Do not place the TP315-102 in direct sunlight, near heaters or heat-radiating appliances, or near any liquid. Exposure to direct sunlight, smoke, or steam can harm internal components.
- Handle the TP315-102 carefully. Dropping or jarring can cause damage.

- Do not pull any cables attached to the TP315-102.

1.3 Cleaning

- Clean the TP315-102 with a dry cloth only. Never use strong detergents or solvents such as alcohol or thinner.

1.4 FCC Notice

- This device complies with Part 15 of the FCC Rules. Operation is subject to the following two conditions: (1) This device may not cause harmful interference, and (2) this device must accept any interference received, including interference that may cause undesired operation.
- This equipment has been tested and found to comply with the limits for a Class B digital device, pursuant to Part 2 of the FCC Rules. These limits are designed to provide reasonable protection against harmful interference when the equipment is operated in a commercial environment. This equipment generates, uses, and can radiate radio frequency energy and, if not installed and used in accordance with the instructions found herein, may cause harmful interference to radio communications. Operation of this equipment in a residential area is likely to cause harmful interference in which case the user will be required to correct the interference at their own expense.
- Any changes or modifications to the unit not expressly approved by Altinex, Inc. could void the user's authority to operate the equipment.

2. Installation Procedures

Note: Download and read the entire online manual to become familiar with the TP315-102 and for detailed installation instructions, including multiple receiver wiring.

Step 1: Connect the TP315-102 Receiver to the TP315-101 Transmitter using any 2 wires or 2-conductor cable. For best results, use 24 to 12 gage wire; the 12 gage limitation is due to the opening in the terminal connector.

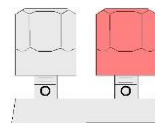

The terminals are red and black, but there is no polarity. Connect either wire to either terminal.

Step 2: Connect the TP315-102 to AC power using the cord provided.

Step 3: Connect the display to the HDMI output on the TP315-102 using the HDMI cable provided.

Step 4. The Anywire receiver is now operating. Once the transmitter detects the receiver, video is displayed automatically.

Step 5. The Anywire Transmitter/Receiver pair allows IR pass-through from the receiver (far side) to the transmitter (near side). An IR receiver is included with the TP315-102 and may be connected to the HDMI display (or anywhere accessible to the user) allowing a remote control on the user/receiver side to control the source on the transmitter side of the Anywire installation. The Anywire transmitter includes an IR emitter.

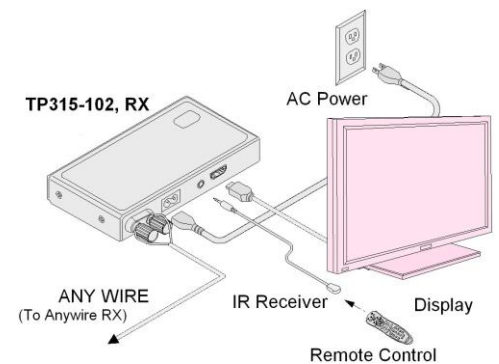

3. Warranty and Return Policies

Please visit the Altinex website at www.altinex.com for details on warranty and return policies. In the case of a unit needing repair, please complete a RMA (return material authorization) form by clicking the Warranty link located on the bottom of the Altinex homepage. Once completed, please email the form to support@altinex.com.

4. Technical Specifications

Specifications are subject to change due to design improvements. Please see www.altinex.com for up to date information.

Features/Description	TP315-102
Input Connectors	
Anywire Video	Terminal Post F (2)
IR Receiver	3.5 mm Audio F (1)
AC Power	C7 M (1)
Output Connectors	
Digital Video + Audio	HDMI F, Type A (1)
Compatibility	
Signal types	HDMI
Signal resolution	HD Resolutions up to 1080p
Accessories Included	
HDMI Cable	n/a
AC Power Cord, NEMA 1-15P to IEC C7	n/a
IR Receiver	n/a

Table 1. TP315-102 General

Mechanical	TP315-102
Material	Aluminum
Color	Black
Height	1.05 in (27 mm)
Width	6.73 in (171 mm)
Depth	3.51 in (89 mm)
Weight	1.0 lbs. (0.45 kg)
T° Operating	10°C-45°C
Humidity	90% non-condensing
MTBF (calc.)	38,000 hrs.

Table 2. TP315-102 Mechanical

Electrical	TP315-102
Video Input Signals	
Digital Video + Audio	Anywire
Video Output Signals	
Digital Video + Audio	HDMI Standard
Power	
100~240 VAC	7 W max. 100 VAC at 70 mA 240 VAC at 30 mA

Table 3. TP315-102 Electrical

5. About Your TP315-102

- HDMI over 2-conductor cable
- Automatic input detection
- HDMI resolutions up to 1080p
- Transmission up to 300 m
- IR pass-through control

The TP315-102 HDMI over Anywire receiver allows the receipt of 1080P HDMI signals up to 300 m using a simple 2-conductor cable. A single transmitter is capable of driving up to 4 receivers using either 4 individual wire pairs over 300 m each, or by daisy chaining the receivers. The only restriction being the wire pair from the transmitter to each receiver cannot be bundled together as crosstalk will occur.

The TP315-102 is an economical solution for many audiovisual installations. The 2 wire solution makes installation easy without the need to cut and splice wires and install expensive connectors or purchase costly cables. Simply route your wires, cut and trim the installation and connect to the terminals. That's it!

The unique design of the Anywire Receiver provides stable video over greater distances than other designs. IR pass-through for receiver side to transmitter side control is provided without corrupting the HDMI signal during transmission of IR signals.

Operation does not require any user control or interaction. Simply connect the Anywire input and when the transmitter detects the receiver the receiver begins video transmission to the display.

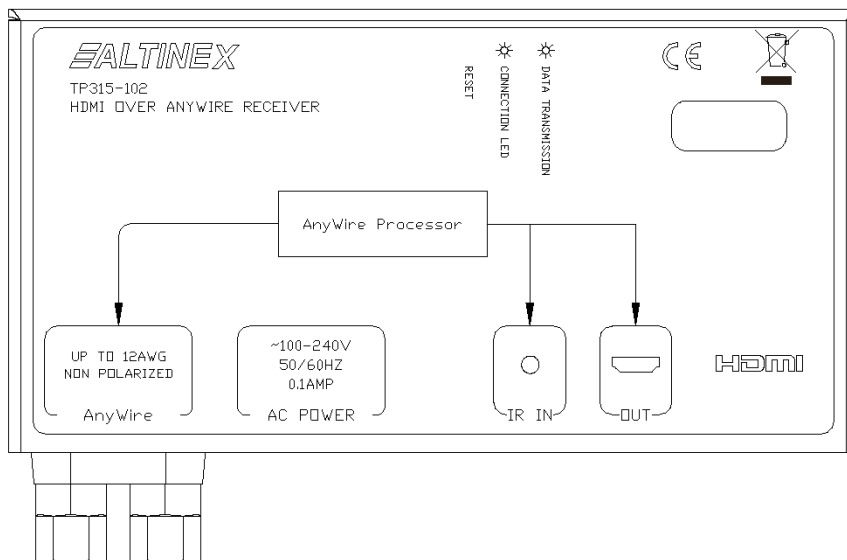

6. Application Diagrams

Diagram 1: Typical Setup

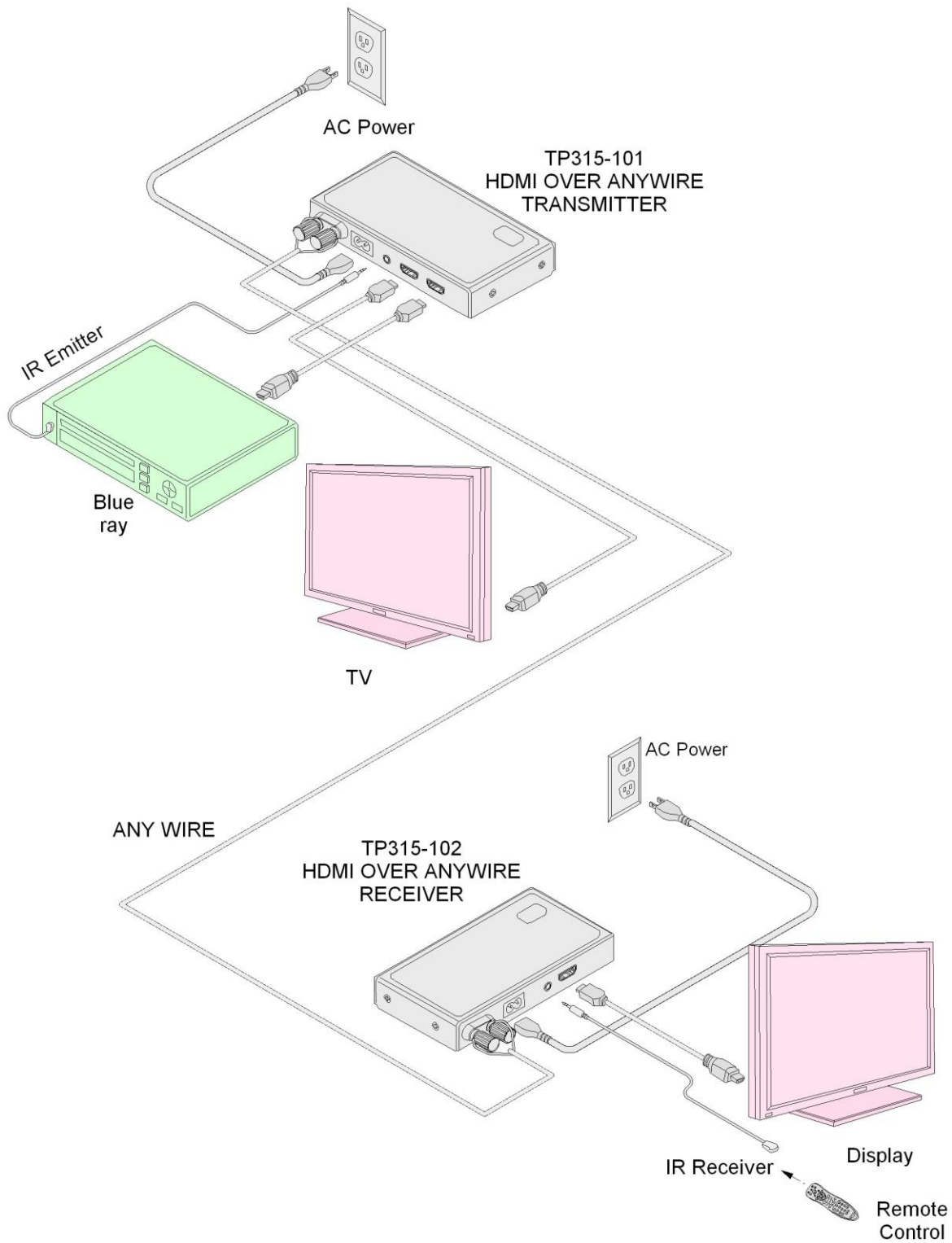

Diagram 2: Internal View

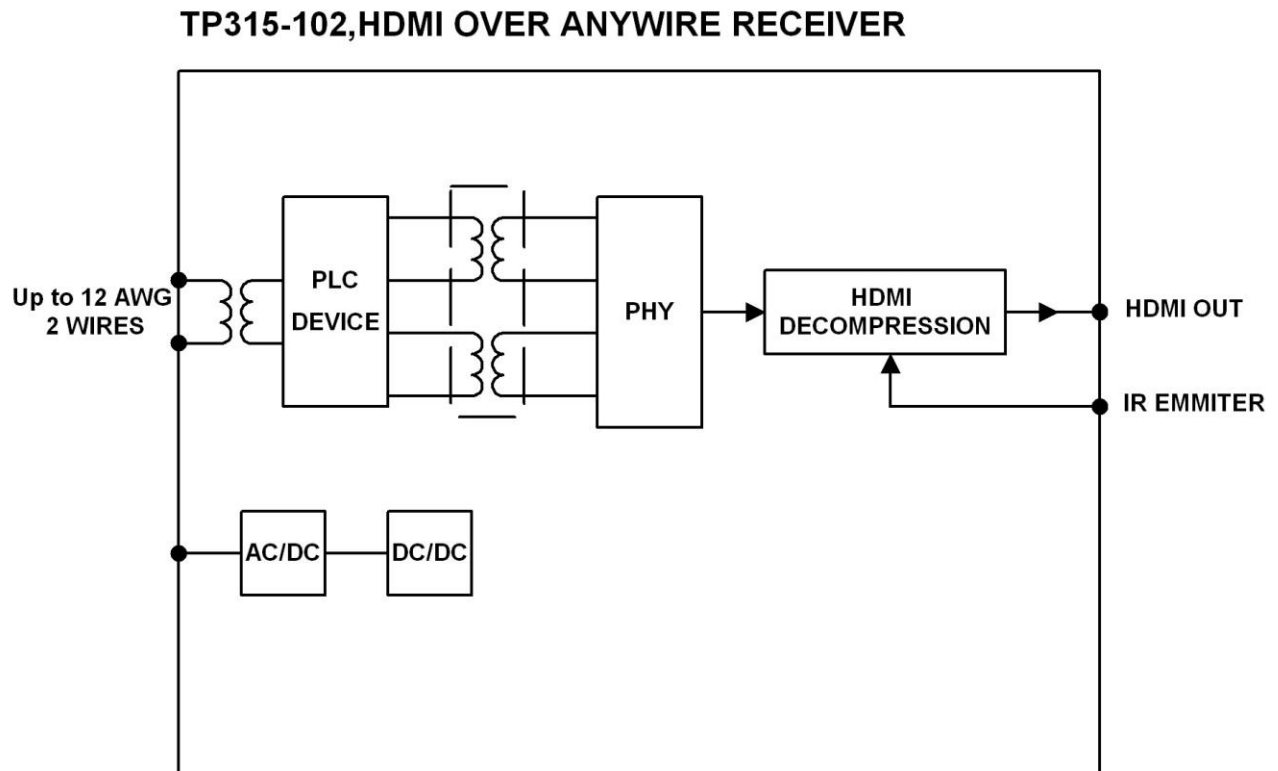

Diagram 3: Dimensions

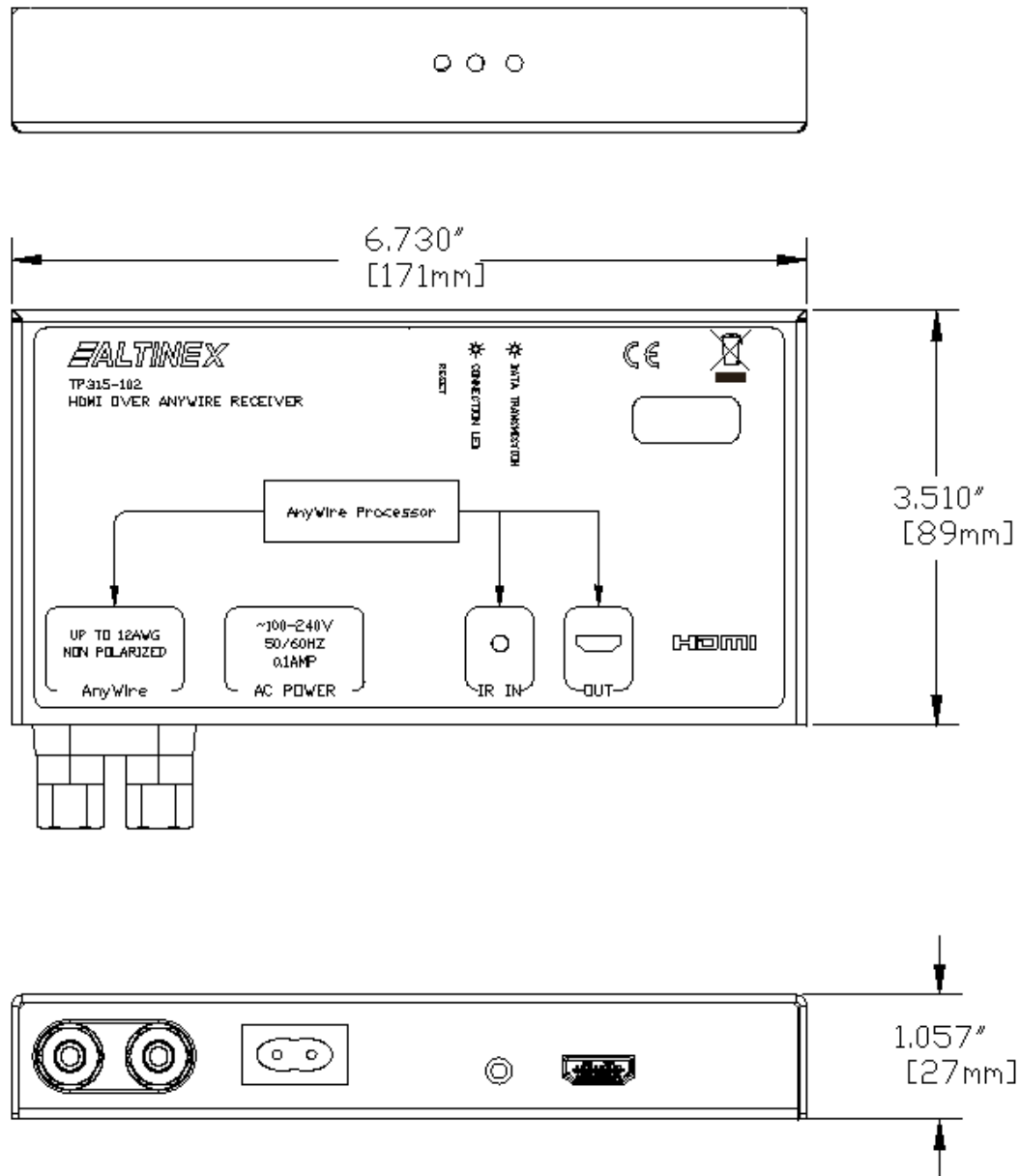
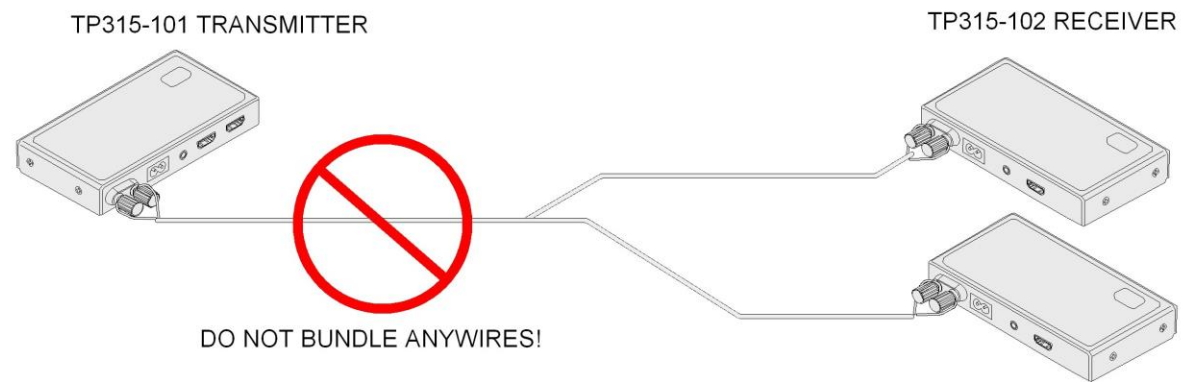
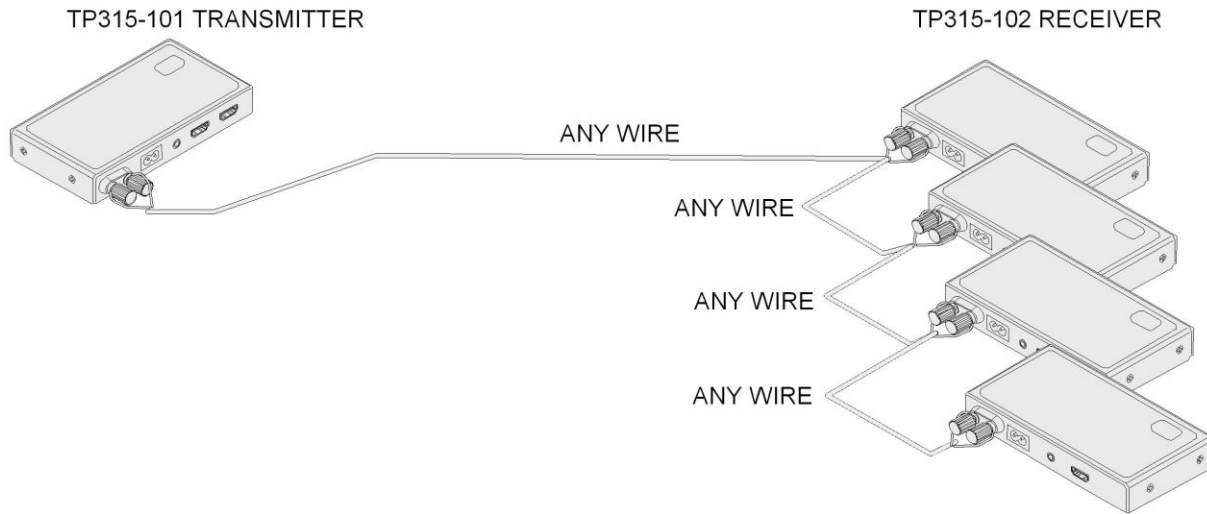
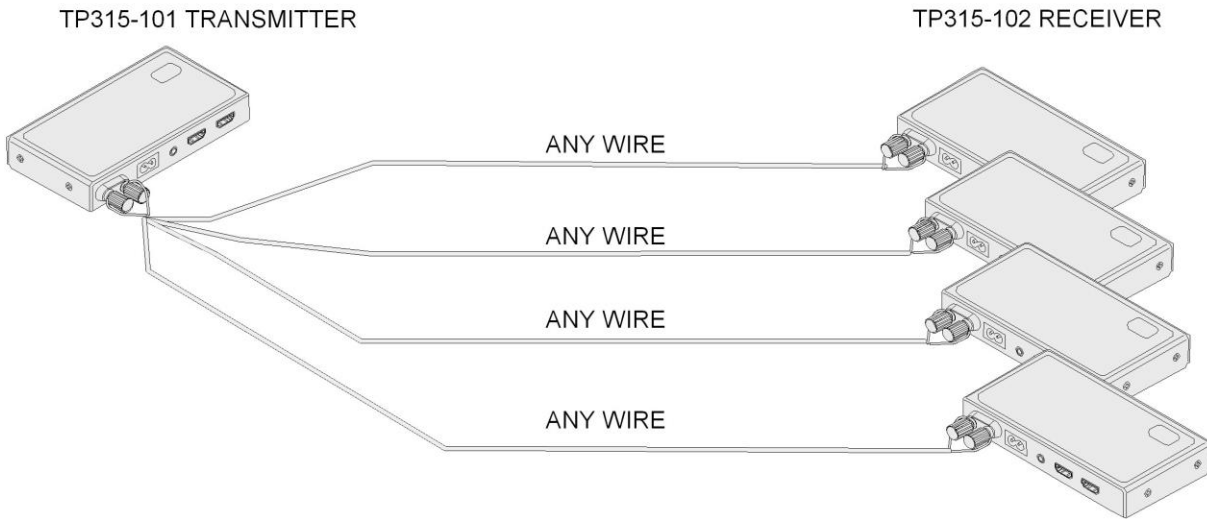

Diagram 4: Multiple Receiver Setup



7. Operation

The TP315-102 requires no adjustments for performance. Once set-up, the TP315-102 Anywire Transmitter will work trouble-free without user intervention.

7.1 Reset Button

A reset button is provided on the side of the unit to allow a forced reset without having to disconnect power. Use this only if there are problems connecting to the receiver; typically after a new display is installed or after a power outage.

8. Troubleshooting Guide

We have carefully tested and have found no problems in the supplied TP315-102. However, we would like to offer suggestions for the following:

Anywire	
Symptom	Resolution
LEDs on Are Off	<p>The unit may not be receiving power.</p> <ol style="list-style-type: none"> 1. Make sure the unit is plugged into a working AC outlet. Use only the power cord provided. 2. The Connected LED should be on and green.
Data Transmission LED is flashing very slow	<p>The transmitter and receiver are not communicating.</p> <ol style="list-style-type: none"> 1. Check the 2 wire connection; make sure both wires are connected. 2. Make sure the transmitter is powered on. 3. Press the reset button on the side of the unit or reset power to force the transmitter to try and re-establish a connection.
No Display	<p>The HDMI input signal may be missing.</p> <ol style="list-style-type: none"> 1. Check the source and make sure there is a signal present. 2. Make sure both the TP315-101 and TP315-102 are powered and the Connected LEDs are both green. 3. Make sure the monitor has power and is turned on. 4. Verify the monitor is connected to the TP315-102 Receiver's HDMI output 5. Make sure the monitor's correct HDMI input number is selected.
Poor Output Image	<ol style="list-style-type: none"> 1. The source resolution may not be compatible with the projector or other display device. Try other resolutions from the source. 2. The source and display may not be compatible. Connect the source directly to the input of the projector or other display device. If the image is poor the devices may be incompatible. 3. If using multiple receivers, make sure that the transmission lines are not bundled together at any point in the transmission. If the cables are bundled (zip tied together) this causes crosstalk between the different channels and can result in image problems.